

CLEANUP TOOLS

Although cleanup tools have many uses, they are primarily used to "clean up" slip-cast greenware by removing imperfections (seam lines and mold marks) and enhancing and sharpening cast-in details.

K23	6"		\$2.79
K24	6.5"		\$2.79
B3	6.5"		\$2.69
BB	8.5"		\$2.99
A2	8.5"		\$3.69
DPC	10.5"		\$3.09

DETAIL CARVING TOOLS

The curved blades of these tools are formed and precision ground to provide a very sharp cutting point that will easily carve miniature details such as facial features, hair, insignia, fingers, and jewelry on small ceramic figurines.

DCL	5"		\$3.99
DCS	5"		\$3.49
K26	4.5"		\$2.89
LFTS	5.5"		\$9.89 Set of 3

LACE TOOLS

Lace tools are designed to facilitate the application of slip-soaked lace to greenware boxes, figurines, etc. The curved, pointed blades are used for pressing lace in place and also cleanup and sgraffito work, as well as working in wax.

AB	6.75"		\$2.89
A3N	6.75"		\$2.89
A3R	6.75"		\$2.89
K21	6.5"		\$2.69
K25	6.5"		\$2.89

CUT-OUT TOOLS

COR	4.5"		\$2.99
COH	5.75"		\$2.99

CLAY LIFT SETS

Makes the creation of new decoration patterns and varied effects possible. Difficult to obtain details such as feathers, plant details, petals, and scales are easily done with spoons contoured for easy insertion, lifting and removal from moist clay. 7"

CLS-A		\$7.29
		
		
CLS		\$6.99

SGRAFFITO TOOLS





K27	6"		\$2.59
WLS	6.25"		\$2.99
BSS		\$2.19	
BSL		\$2.49	
DBSS		\$2.69	
DBS		\$2.69	
WS	6"		\$4.09

DRILL TOOLS

DR2	5.5"		\$2.09
DR4	4.75"		\$2.09
DR6	4.5"		\$4.99
SPD	6.75"		\$3.69

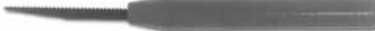
3/16" 1/4" 1/30" 1/16" 1/12"

SAW TOOLS

SBR	5-3/8"		\$2.99
K31	5-3/8"		\$3.69
K32	5-3/8"		\$3.89
GBC	6"		\$3.99

TRIMMER KNIVES

K34	5"		\$2.39
UK	5.75"		\$3.69
UKS		\$6.79	
SCP		\$1.69	

CUT-OFF NEEDLES

PCN	5.5"		\$0.95
PRO	6.75"		\$2.19
PNH	5"		\$1.99

RECESS SMOOTHER

K20	6"		\$2.89
-----	----	--	--------

Tools

HOLE CUTTERS

Hole Cutters provide an easy method for cutting clean holes in wet thick-wall greenware and wheel-thrown items.

HCP1 1/4"		\$5.99
HCP2 3/16"		\$6.69
HCS1 3/32" sq.		\$4.29
HCS2 1/8" sq.		\$4.99
HCS3 3/16" sq.		\$5.19
HCS4 7/8" sq.		\$5.99
HC13/16"		\$3.09
HC1A 1/4"		\$3.19
HC2 5/16"		\$3.39
HC3 1/2"		\$3.99
HC4 7/8"		\$7.99
MDT		\$2.79

TEXTURING BRUSHES



DG1 6.5"		\$3.69
WG2 6.5"		\$3.69
FTB 5.5"		\$2.79
SWB 5.5"		\$3.79

HANDLEMAKERS

HM1 4" (For Pitchers)		\$2.39
HM2 4" (For Mugs)		\$2.39

RE RIBBON TOOLS

These tools combine imported hardwood modeling ends with sharpened stainless steel ribbon cutting ends.

RE2 8-3/8"	
RE3 9-3/4"	
RE4 8-1/4"	

\$7.29 each

8 INCH DOUBLE WIRE END TOOLS

This assortment of 8-inch tools provides the sculptor and potter with a series of shapes designed for medium duty cutting and slicing of clay. The wire ends are formed from high-strength, stainless steel and are firmly attached to hardwood handles with brass ferrules.

\$4.99 each

8A1	
8B2	
8C3	
8D4	
8E5	
8G7	
8H8	

WIRE TOOLS

Wire end tools are used to remove controlled amounts and shapes of clay. These 6-inch tools are suitable for light cutting and slicing. The ends are made from high-strength music wire and are firmly attached to the hardwood handles with brass ferrules.

\$2.99 each

D1	
D2	
D3	
D4	
D6	
D7	
D8	
D9	
D10	

FETTLING KNIVES

These knives are used to trim the pour hole waste and to remove mold marks from cast greenware.

\$5.89 each

F96 8" Softer	
F97 8" Harder	

6-INCH RIBBON TOOLS

These tools provide a variety of shapes for light cutting and slicing. The ends are formed from high-carbon, heat-treated steel and are firmly attached to the handles with brass ferrules. **\$2.99** each



8-INCH RIBBON TOOLS

These tools are used by potters and sculptors for medium duty clay cutting, shaping, and slicing. The cutting ends are formed from high-strength sharpened stainless steel and are firmly attached to hardwood handles with brass ferrules. **\$3.79** each

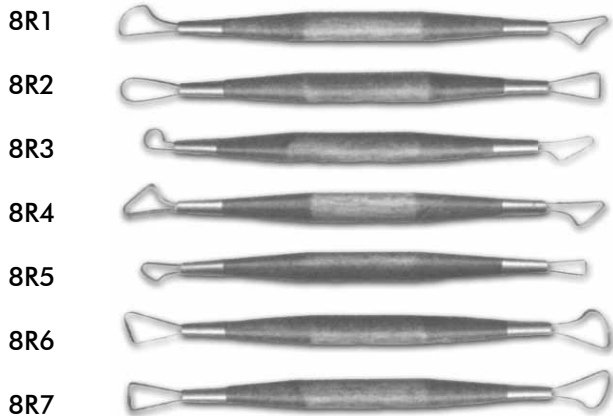

HEAVY DUTY SCULPTING TOOLS

Heavy duty tools designed to withstand the heavy side loads encountered when working on large sculpture and wheel thrown pieces. Made of stainless steel flat ribbon. **\$3.49** each



FW32 FW31 FW11 FW12 FW22 FW21

5-INCH WIRE AND WOOD TOOLS

Wire and Wood Tools are combinations of wood modeling tools and wire tools. The 5-inch and 6-inch Wire and Wood Tools are used for delicate clay removal, modeling and shaping. They are made with plated high-strength .024" diameter music wire, brass ferrules, and imported hardwood.



6-INCH WIRE AND WOOD TOOLS

You will find the .035" diameter music wire great for light, as well as delicate clay removal and shaping. **\$4.79** each



8-INCH WIRE AND WOOD TOOLS

Used for medium duty clay removal, modeling and shaping. The wire ends are .055" in diameter, and formed from high-strength stainless steel. Tips are firmly attached to 8" long hardwood handles with brass ferrules.



Tools

LOOP TOOLS, 5"

Loop Tools are used to remove controlled amounts of clay from wheel-thrown and sculpture pieces. The shaped cutting heads are made from heavy stainless steel ribbon with sharpened edges. Each tool, with its rugged hardwood handle, ensures a sure grip and easy manipulation in wet clay. **\$3.49 each**

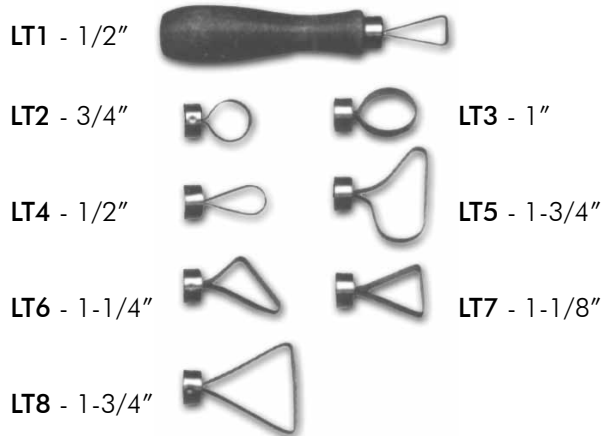

IMPORTED WOOD MODELING TOOLS

This set contains twelve 6 inch imported wood modeling tools. Designed with the student in mind as well as the experienced sculptor. The set offers a wide variety of shapes for cutting, slicing, smoothing, contouring, and pattern decorating in soft clay. **\$1.39 each**

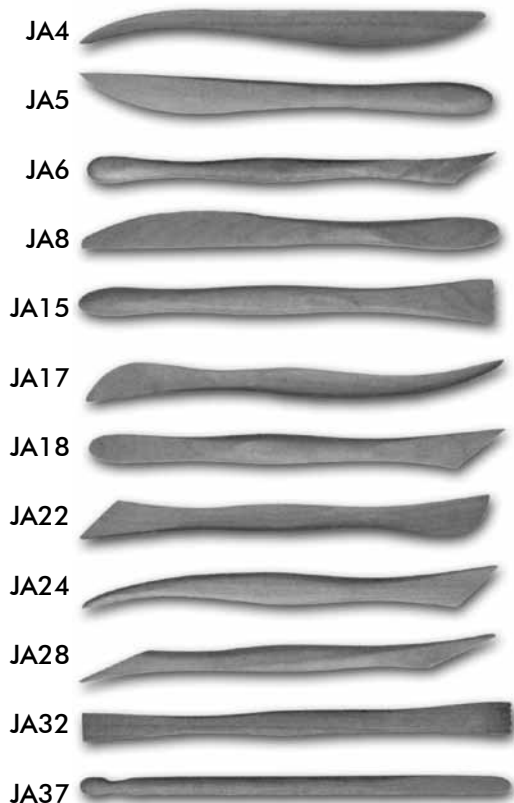

WOOD MODELING TOOLS

This series of wood tools offers a wide variety of shapes and contours for basic clay modeling. They are used for cutting, slicing, smoothing, contouring and pattern decorating in soft clay. They are made from imported hardwood and have a satin smooth finish.

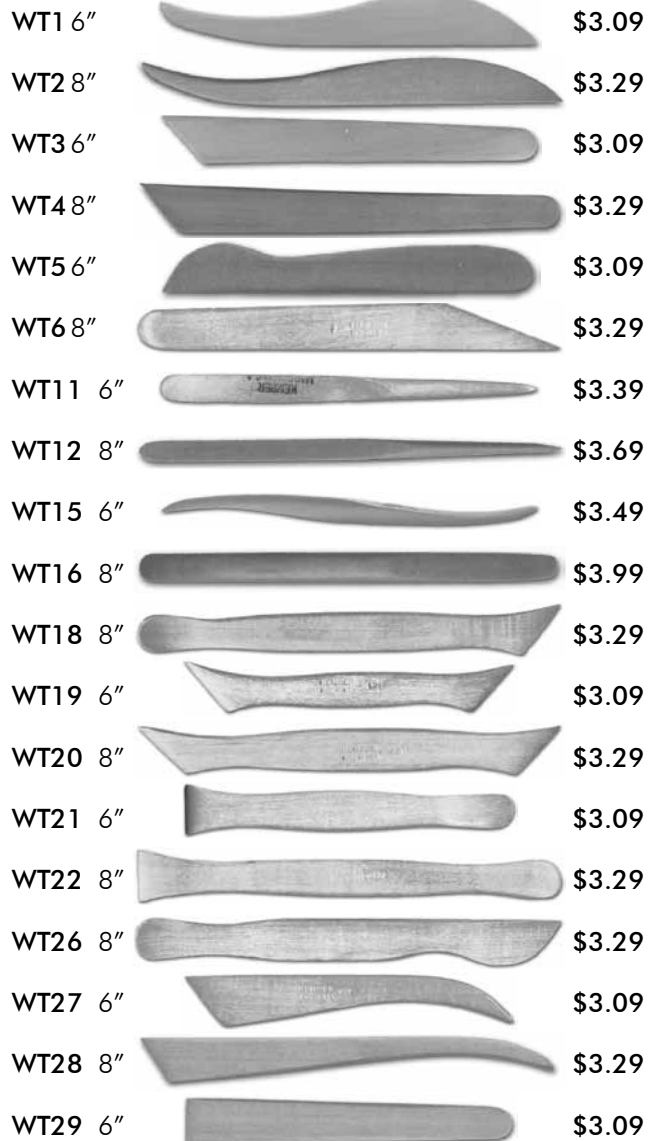

PALETTE KNIVES

Palette Knives are used by artists and ceramic hobbyists for patching greenware, and grinding and mixing small quantities of china paints, oils, slips and glazes.





POTTERY TOOL KIT

Perfect for the beginning potter, in or out of the classroom. Used by schools and universities around the world, this kit is packaged in a reusable, clear vinyl bag with pockets to keep your tools together for travel or storage. **\$17.99**

MINI RIBBON SCULPTING TOOLS

These miniature sculpting tools are made of fine ribbon steel heat treated for maximum strength. They are just the answer for your fine sculpting, detailing, and trimming requirements. **\$2.59 each \$13.99 set**

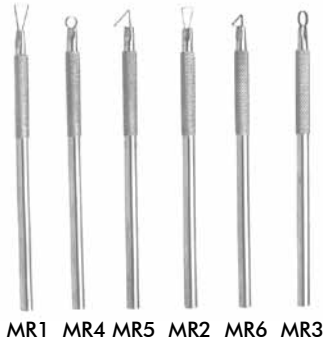

TURNING TOOLS

Heavy steel head are brazed to steel shafts, plated and firmly set into smooth hardwood handle. Made to accurately shape clay or plaster on the wheel.



TT1	Large Pointed Oval	9-3/4"	\$9.29
TT2	Small Pointed Oval	9-3/4"	\$9.29
TT3	Triangle	9-3/4"	\$9.29
TT4	Right-hand half moon	9-3/4"	\$9.29
TT5	Left-hand half moon	9-3/4"	\$9.29

STEEL TRIMMERS

Made of heat-treated tool-steel, hand sharpened for a superior cutting edge and covered with a rust-preventative coating.
C15 - 5-1/4" - Blue
C19 - 6-3/4" - Red
\$10.50



FLUTING TOOL

Stainless Steel. Create flutes (curved end) or scallops (pointed end) in "leather hard" clay. The

wings on either side of the cutting edge will maintain a uniform depth in the clay for parallel even lines. Size 7". **\$13.75**

VAN GILDER UNDERCUT TOOL

Use this tool to undercut a bevel at the foot of a thrown pot and then use the long beveled edges to rib your pot into shape. **\$6.00**



THROWING STICKS

Patterned from the Japanese egote, these throwing sticks aid in shaping and compressing deep and narrow necked wheel thrown pieces. They are made in two sizes of fine imported hardwood polished to a satin smooth finish. 12-1/2"

TS1  **\$10.69**

TS2  **\$10.69**

DOUBLE "O" RIB

This rib is handcrafted and finished from imported hardwood. It is used for cutting, slicing, shaping, and smoothing soft clay.

12" **\$7.29**



SCULPTOR'S THUMB

This is a compact hand-fitting tool that duplicates thumb and finger strokes without abrasive wear on the sculptor's hands, fingers and thumbs. The Sculptor's Thumb is made from hardwood, 5" long and fits in most hands comfortably.

STH **\$6.49**



PUTTY KNIFE

Wood handle. Set of three: 1.25", 2" and 3" in width. **\$3.00/set**



TOUGH KNIFE



Sharp curved blade, wooden handle. 7" **\$3.00**

The most efficient hole-cutting tool you'll ever use! The no-clog design makes hole-cutting quick and easy. Cut holes from 1/16" to 1/2" in diameter - with one tool. Hardwood tapered handle is 2-1/2" in length, metal cutting blade is 2-3/4" in length. **\$12.00**

HOLE CUTTER



SPOUT MAKER

Made from solid maple. Used to make spouts, feet, designs, appendages, and decorations. 8"



\$9.14



ULTIMATE SPOUT MAKER

Use to make long narrow and thin ceramic handmade spouts with length up to 15" long. **\$14.37**

Tools

Wire Cutters

KEMPER CLAY CUTTERS

3" hardwood toggle handles are firmly fastened to 18" of frame quality stainless steel wire or fine quality nylon wire.

K-35	Steel	\$2.59
K-36	Nylon	\$2.59



KEMPER EXTRA LONG TWISTED WIRE CUTTER

4.5" toggle handles are firmly fastened to 34-1/2" of fine quality stainless steel twisted double wire for a thicker cut.

K-37T \$3.59



CUTTING WIRE

26" \$2.90



SHERRILL MUDCUTTER

Designed to slice and cut pug and extrusions for hand building, or for use on the wheel. Made of plastic and stainless steel. Available with twisted or straight wire. \$30.00



PORTION MASTER CLAY CUTTER

This adjustable clay cutter is simple to use, just grasp with both hands and slide into position, pull or push through clay. 9" x 6" \$15.50

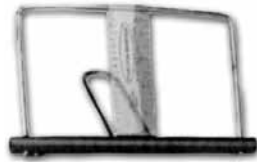

VAN GILDER WIGGLE WIRE

Add attractive patterns to the bottom surface of each pot you make. Pull and wiggle this sturdy corrugated wire tool beneath each form as you cut it from the wheelhead to create an assortment of subtle linear patterns. \$6.50

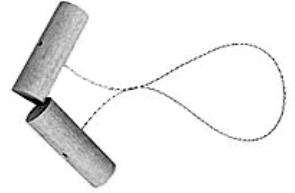

VAN GILDER ALUMINUM WIRE KNIFE

Designed to comfortably fit the hand. Unlike a flat knife blade, the ultra-thin textured and tensioned wire cuts through clay without drag or distortion. Use it to trim teapot spouts and handle

ends, facet, cut-out feet and more... 3" wire length in a 5" x 3/4" U-shaped frame. \$16.50



ADJUSTABLE CLAY SLICER

A heavy duty adjustable clay slicer for controlled cutting of very thin to one half inch slivers. Made from aluminum with stainless steel wire. \$6.00

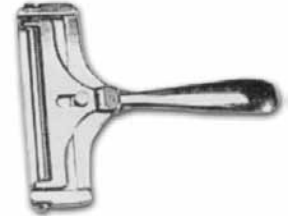

VAN GILDER HUMP CUT-OFF TOOL

Use the beveled pointed end to cut a groove, and then the string to remove the form from the hump. 8" \$6.00



BEVEL CUTTER

Allows you to cut precision 45 and 60 degree angles into your slabs. 4" \$7.00



Water Buffalo Horn Tools

These traditional Chinese tools, made from genuine water buffalo horn, are perfect for sculpting moist clay work and burnishing clay surfaces when wet or leather hard.

HY-7	5"		\$7.50	HY-1	6.5"		\$3.00
HY-8	5"		\$8.00	HY-2	6.5"		\$3.00
HY-9	3"		\$4.00	HY-3	6.5"		\$3.00
				HY-4	6.5"		\$3.00
				HY-5	6.5"		\$3.00
				HY-6	5"		\$4.00
				Set of all 6			\$16.00

Dolan Tools

All Dolan tools are handmade from the high carbon knife steel and are designed to with the production potter in mind.

Tools

300 series \$10.75



400 Series \$9.75

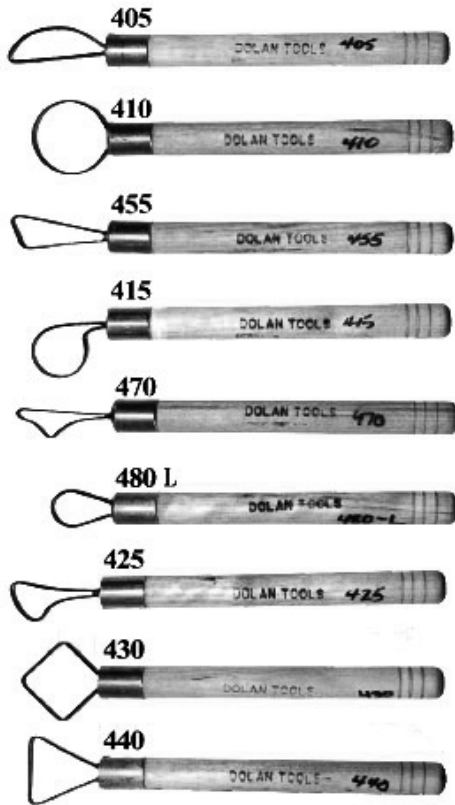

100 Series \$10.75

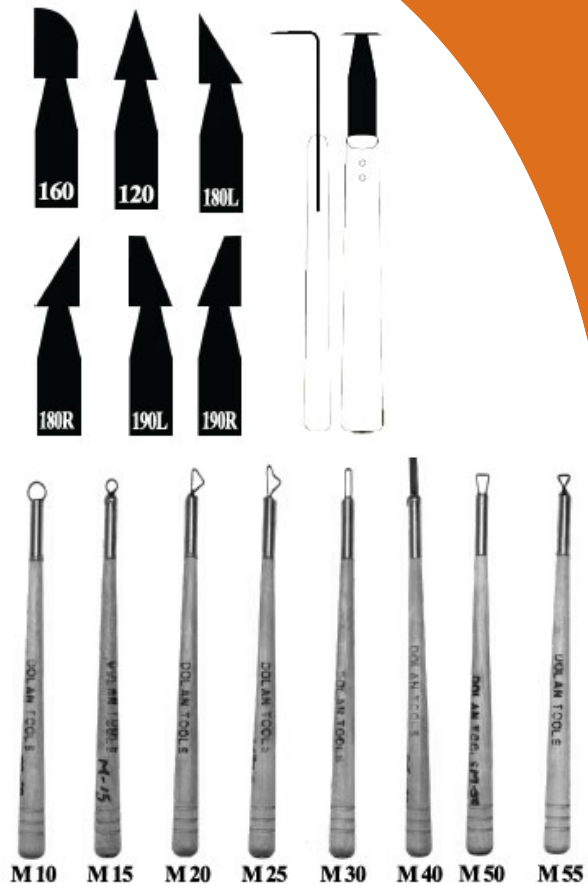

220-C \$11.95

"M" Series \$6.50

Clay Shapers

KEMPER WIPE OUT TOOL (WOT)

Erase your mistakes quickly and accurately with this specialized rubber that attracts gold as well as most painting mediums. For use on non-porous surfaces.
\$5.59



CLAY SHAPER

Rubber tipped.
Set of 5.
\$17.00



Calipers

Calipers are used by potters and sculptors to transfer measurements from the model to the clay and to measure thickness and diameters. The hardwood caliper is made from imported hardwood. The aluminum calipers are made from a tough aluminum alloy, are lightweight and easy to handle, and will measure both inside and outside dimensions.

HARDWOOD CALIPER
CA10 10" \$8.99

ALUMINUM CALIPERS
AL8 8" \$6.89
AL10 10" \$7.79
AL12 12" \$9.29



LID MASTER CALIPERS

Take the guesswork out of sizing lids for your pots. One tool is all you need. Simply insert the narrow end of Lid Master into the pot and the wide end automatically becomes a sizing guide. Use it to create perfect fitting lids quickly and efficiently every time.
Standard \$12.95
Large \$24.95



Tools

Shimpo Throwing Tools

THROWING DISCS

Used for shaping, compressing or burnishing.
 Small \$4.00
 Medium \$4.00

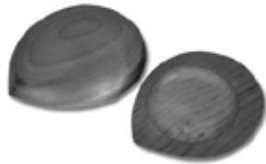

LARGE THROWING TOOLS

These tools are used for shaping or compressing wheel thrown work.
 Small \$20.64
 Medium \$21.94
 Large \$23.04



WOODEN TROWING STICKS

These throwing sticks are used for shaping wheel thrown work on a wheel rotation of clockwise or counter-clockwise.
 Small \$7.20
 Medium \$8.00
 Large \$8.80



SHORT THROWING TOOLS

These tools are used for shaping or compressing wheel thrown work.
 Small \$18.96
 Medium \$20.26
 Large \$21.36

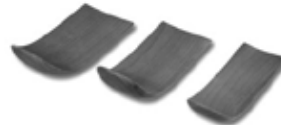

COMBING TOOLS

These combing tools are used for creating surface decoration.
 Small \$11.12
 Medium \$11.76
 Large \$13.04



BAMBOO SCULPTURE TOOL SET

Four piece tool set made of solid bamboo. Great bargain.
 \$4.00



STEEL TRIM TOOLS

Set of 8 tools made of manganese steel. "6.5
 \$24.00



WOOD THROWING KIT

Full Set \$18.00
 Wood Paddle 13.5" \$5.00
 Cutting Wire 26" \$2.70
 Wood Point Head 10" \$5.00
 Wood Spoon Shape 11" \$5.00
 Wood Round Stick 12.5" \$4.00

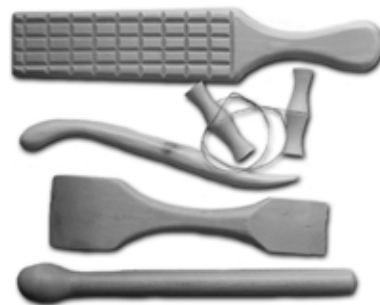

THE STEVE TOOL

A texture application tool that can be configured into many variant designs by rearranging the disks over the shaft in assorted patterns.
 \$18.40



BAMBOO PADDLE

\$1.00



SCISSORS

Stainless and heavy



duty. 17 cm.
 \$3.00

SCUPLTING KNIFE SET

Set of 4 tools. "7.5
 \$28.00



SHERRILL MUD SHREDDER

A small handy pot-sized sheer form tool.



\$8.00 each

PLASTER RASPS

Perforated steel rasps for plaster.

9"  \$12.00

7-1/2"  \$11.00

6-1/2"  \$10.00

Slip Trailers & Decorators



PRECISION DECORATOR

Two bottles and four stainless steel tips allow you to draw intricate designs with underglaze, glaze, slip, and non-fired paints in four different widths. Can also be used to apply mender or wax resist.
\$6.95



KEMPER SLIP TRAILING BOTTLE

Used to flow casting slips, glazes and engobes onto ceramic pieces in raised decorative designs. With a 4-ounce capacity, this bottle is made from polyethylene making it squeezable, easy, and light to hold. Can be sealed with top.
\$2.99

FALCON APPLICATOR BOTTLE

Heavy duty 2 oz. round polyethylene bottle with a 16 gauge opening, steel 1 inch long needle equipped with a dust proof cap. Can be used to apply all types of glazes, slips, wax resist, glue, and other media.
\$5.25

PLASTIC SLIP TRAILER

\$1.00



SLIP TRAILER

The perfect size for slip trailing on all sizes and types of pottery.
\$12.80



SQUEEZABLE BOTTLE

An easy and economical way to apply wax resist, colored slip or underglazes. Keep all your colors available in 2 ounce, see through, airtight bottles. The bottle is made of squeezable plastic and has an attached closing cap.
\$0.69

Ceramic Stamp Molds

Use these ceramic molds to make for mass production pieces. Much stronger than plaster molds. Made from clay designed to maximize detail.



OCEAN LIFE SET

Includes molds to make fish, sea shells, sea horses, turtles, crabs and lobsters. 10 molds.
\$20.00



GARDEN LIFE SET

Includes molds to make frogs, snails, ladybugs, butterflies, and turtles. 5 molds.
\$12.00



VEGETABLE SET

Includes molds to make eggplants, peppers, carrots, corn, cabbages, and squash.
\$14.00

Tools

SCOTT CREEK TILE CUTTERS

Sturdy metal cutters produce perfect tiles time after time. Sized for clay shrinkage.



4" \$31.25
6" \$47.00

ASSORTED PLASTIC TILE CUTTERS

24 pieces, 6 shapes, 4 sizes each shape. Size: 1-1/4" - 4-3/4" (3cm - 12cm). \$14.00

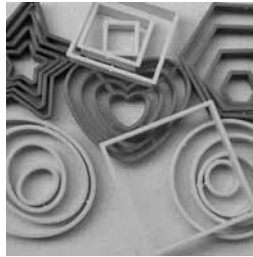

RUBBER STAMPS

Add uniform text and numbers to your ceramics project.

Size	Letters	Numbers
10-6 0.2"	\$3.00	\$1.40
10-5 0.3"	\$4.00	\$1.80
10-4 0.4"	\$5.00	\$2.20
10-3 0.5"	\$5.90	\$2.80
10-2 0.7"	\$9.20	\$3.90
10-1 0.9"	\$10.00	\$4.50
10-9 1.4"	\$16.00	\$8.00



ROSE CUTTER SET

The Rose Cutter Set consists of five round cutters and instructions for use. The cutters are used just like a cookie cutter on rolled-out clay to make round pads. These pads are then easily hand formed to resemble rose and other flower petals. Sizes range from 1/2" to 1-1/2" in diameter.



K50 \$7.99

TEXTURED BLOCK SET

Add an interesting texture to your coiled handles by rolling coils of clay between these two non-stick corrugated boards. Position the boards at different angles and directions to produce an assortment of great textures: linear cross-hatching, twisted spirals, circular rings, straight-line grooves, and more! Base board is 6" x 6" x 1/2" thickness; top board is 5" X 5" x 1/2" thickness Made of hardwood. \$16.00

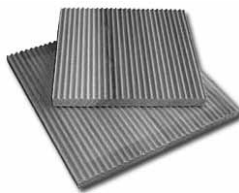

TRIANGULAR COMB

The solid stainless steel Triangular comb has 4" three different sized comb points, and a hanging hole. \$4.76



PLASTIC TEXTURE MATS

The Plastic Texture Mat is a patented clay tool for making textures on the surface of wet clay. The artist or student can use the textured clay to build many different forms. 8" X 12".

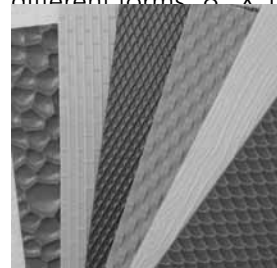

Pattern	Price
Bricks	\$12.00
Rocks	\$12.00
Fish Scales	\$12.00
Wood	\$12.00
Dragon Scales	\$12.00
Basket Weave	\$12.00
Set of Six	\$55.00

DECO ROLLERS

Sets include a handle and wheel assembly with instructions and 6 patterns. Pattern straps measure 1" x 6" \$17.95/set

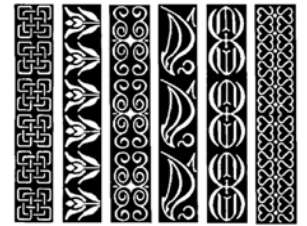

Set A

Set B

MINI DECO ROLLER

Set includes a handle and wheel assembly with instructions and 10 pattern straps.



Pattern straps measure 1/2" x 3 1/2" \$17.95

Pot Lifts

These lifts provide an easy method for removing pottery items from the throwing wheel without damaging the ware. They are made from rust free, high-strength aircraft aluminum.

PL3	4"	\$9.19
PL2	5"	\$9.69
PL1	6"	\$10.99





2-3/4"



3-1/2"



4"



5"



4"



4"

SHERRILL MUD TOOL RIBS

Designed by potter Michael Sherrill, these ribs are made from a material known in the industry as the "stainless steel of plastics" because of its wearing qualities. Unlike rubber this material will not develop burrs. These ribs will actually burnish themselves as you use them. The different stiffness and shapes allow you to find the one to fit your working style. All five ribs come in each of the four styles below. \$7.00

Very Soft - Red

Use for compressing slabs, burnishing rims, chamois, and hand building.

Soft Flex - Yellow

Use for smoothing, burnishing, porcelain, throwing, and hand building.

Medium Flex - Chartreuse

Use for compressing bottoms, burnishing trim marks, throwing, and hand building.

Hard Flex - Blue

Still flexible but stiffer, great for high burnish and large work.

RUBBER RIBS

Designed for smoothing, shaping and finishing clay. Made from pliable rubber.

Black - Hard

4-1/4" \$2.59

3-1/8" \$2.49

Blue -Soft

4-1/4" \$2.59

3-1/8" \$2.49

SCRAPERS & METAL RIBS

Designed for smoothing, scraping, shaping and trimming clay. Made from flexible stainless steel.



S1 4-5/8" \$1.99



S3 4" \$1.99



S4 3-7/8" \$1.99



S6 4" \$1.79



S10 3-3/4" \$2.49



S11S 6" \$3.29



S12 6" \$2.79



VAN GILDER PROFILED FOOT RIB

Produce an instant rounded foot profile by pushing this easy-to-use tool into the base edge of a wet pot on the wheel. Size: 2" x 2-1/2" x 3/8" thickness \$6.00

WOOD POTTER'S RIBS

Made from imported hardwood. Basic shapes for opening, shaping, curving, smoothing and trimming wet clay on the potter's wheel.



RB1 \$4.19



RB2 \$3.79



RB3 \$3.49



RB4 \$3.99



RB5 \$4.99



RB6 \$4.19



RB7 \$3.79

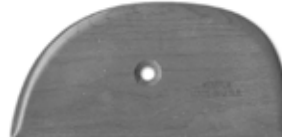

RB8 \$4.99

TRIM GIN METAL RIBS

SS-103

Dye stamped from highgrade stainless steel.

6-7/8" \$10.50



SB-90

Made of half-hard spring-brass for demanding applications.

6-1/2" \$10.50



ULTIMATE EDGER

Ideal for creating clean edges and raised designs. Six different notches allow you to create different edge and lip effects. 4-1/4" x 2"

Small \$11.99

XL \$13.99



6" x 1.5"



3" x 1.5"

SHERRILL METAL RIBS

Stainless steel. Two shapes, each available in three finishes: smooth, small tooth, large tooth. \$7.00

Tools

Mallets and Paddles

MAPLE HAMMER

A heavy duty tool used for mashing dry or wet clay lumps, spreading out clay, decorating, and shaping large ceramic forms. Made from select hard maple. 4" x 2-7/8" head, 10" handle. **\$11.95**



CHINESE CLAY MALLET

A heavy duty hand tool used in China for pounding moist clay lumps to spreading it out flat. The slightly curved face allows the clay to spread out. Made from select hard maple. 5" x 2-7/8" head, 5" handle. **\$30.00**



SOLID WOOD MALLET



Use mallet to pound clay into slabs instead of using a rolling pin or slab roller. The clay becomes much more dense and strong. Sandalwood 13" 1.5 lbs **\$14.00**

WOOD PADDLE

This is a light weight but very strong paddle used for shaping clay. 12" X 4". **\$6.96**



KEMPER KLAY PADDLE

This imported wooden paddle measures 10.25" from end to end, a paddle width of 3.5" at the widest part of the paddle, with a 3" wide end. Use when throwing clay on the wheel. **\$6.95**



ROPE TEXTURE PADDLE

This paddle is used to create texture patterns, compress clay, remove air, and shape clay forms. Birch paddle wrapped with polypropylene rope. 12" x 2". **\$9.25**

Rollers

ROLLING PINS

Made from one piece of kiln dried solid maple, sanded & finished by hand, no plastic or metal parts to rust or wear out.



30"	\$37.00
24"	\$31.00
18"	\$26.00

HARDWOOD THICKNESS STRIPS

For use with Rolling Pins to create slabs of uniform thickness. Four sets of 2 each: 1/8", 1/4", 3/8" and 1/2". All 24" long. **\$17.00**

MINI ROLLER

The mini roller can be used to spread out clay, create textures, flatten small areas, refine small shapes, roll out small pieces, fan out strips, reach difficult areas, and much more. A very handy tool to have around. 5-1/2" solid hardwood. **\$10.35**



VAN GILDER



ROPED ROLLERS

Easy to use and extremely effective for creating 3-D rope pattern decorations on your clay piece. 3" **\$4.50**
5" **\$5.50**



FRENCH ROLLER

Hardwood french roller for smoothing rounded surfaces. 22-1/2" in length **\$26.00**

FLOWER CLAY ROLLER

Fills all your needs for rolling out any kind of clay. Fits perfectly into small hands. FCR **\$3.19**



PONY ROLLER

Two solid hardwood rollers, 4" x 1-5/8" and 2" x 1-5/8", held together with a heavy duty, welded-joint, chromed steel frame. Packed in a poly bag. **\$10.00**

SILICONE ROLLING PIN

Non-stick surface makes rolling and clean-up easy. Contoured handles for a comfortable grip. Counter balanced with consistent easy roll. Stainless steel ball bearings. Colors: Dimensions: 12" x 3"
With metal alloy handles **\$49.95**
With soft-grip rubber handles **\$39.95**
Soft grip handles an steel rod (rather than bearings) **\$25.95**



JUNIOR SILICONE ROLLING PIN

Great for kids. Dimensions: 9" x 1.75" **\$11.95**

MKM Tools

SINGLE AND DOUBLE ENDED THROWING TOOLS

Great for forming narrow forms, especially the shoulders of bottles. The ribs attached to the ends of the throwing tool are interchangeable to fit your throwing needs.



COCORIBS

CocoRibs are made from real coconuts. The thickness and shape of the ribs are dependant on the age of the coconut. Seven CocoRibs come in a set. Set \$16.95

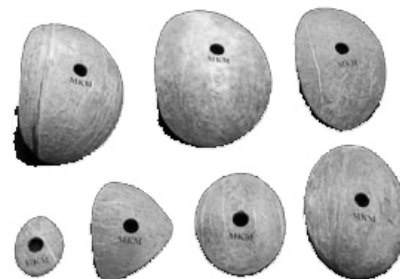

MKM Wood Tools



W2C \$8.95



W22 \$12.95



W9 \$4.95



W2A \$3.95

Tools

MKM Paddles

TEXTURED PADDLES

Each textured paddle has a different pattern on each side and are great for altering the surface of pots, handles and coils.



LP1 \$12.95

LP2 \$12.95

GLAZE PADDLE

Good for 5-6 gallon buckets



Glaze Paddle \$6.95



SP1 \$10.95

SP2 \$10.95

MKM Decorating Disks



DECORATING DISKS

Use these to create square, triangular, or other shaped forms, line up handles and spouts, or marking your piece for glaze or slip patterns. There are perforated holes along the radial lines of the disk which allow you to mark your pot without removing the disk.

4" Decorating Disk \$18.95
15" Decorating Disk \$29.95

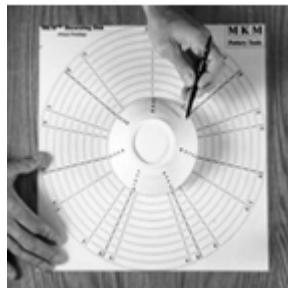

PATTERNED STAMPS

Various double sided wooden stamps in different sizes. \$3.95-6.95

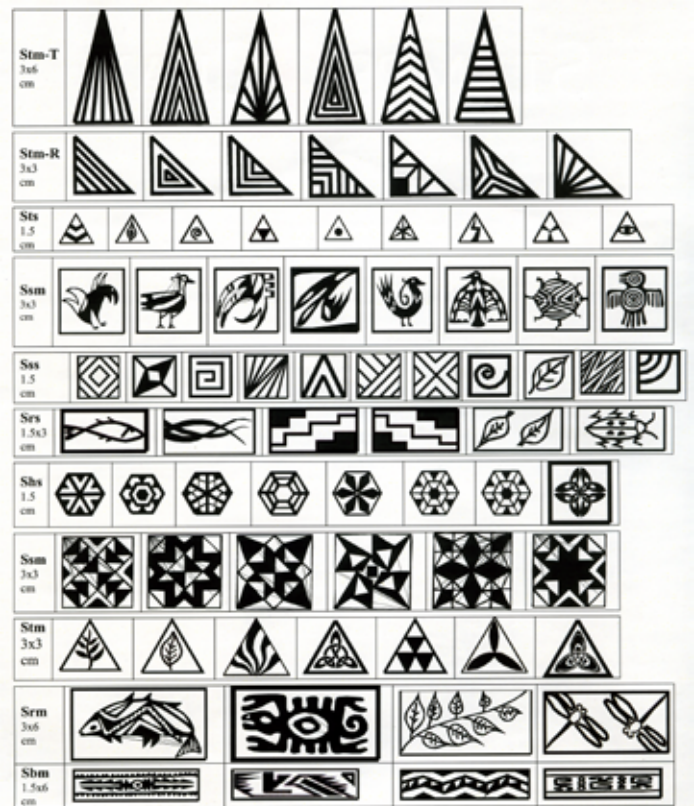

Sponges & Scrubbers

Sponges

NATURAL "ELEPHANT EAR" SEA SPONGES

Medium 2-1/2" - 3" \$2.90
Large 3-1/2" - 4" \$5.10



SYNTHETIC CLEAN-UP SPONGES

2" Round \$0.79
6-1/2" x 4" x 2" Large rectangular \$4.10
5-1/2" x 3-1/4" x 3/4" Med. rectangular \$2.10
5" x 4" x 1-3/4" Small oval \$1.60

SPONGE HOLDER



In order to reach the bottom and inside walls of

some ceramic pieces, it is sometimes desirable to have a sponge on the end of a long handle. This sponge holder has a hardwood handle and special attaching screw to hold your favorite sponge. Comes with a sponge attached.

SPG 14" handle \$3.99
Replacement sponge \$.99

SPONGETTE

These sponges come with two different length handles for convenience. The noninterchangeable sponge is made of soft cellulose material and used not only for cleaning, but decorating as well.

7" \$3.19
14" \$3.39



MUD SPONGE

Sponge shaped like the traditional kidney rib. Tough and consistent. \$5.00



Scrubbers and Scrappers

RUBBER SCRUBBERS

Square 3" X 3" Sponge with sanding surface. Excellent for clean-UP on molds and dolls. Available with 100 or 220 grit surface. \$1.29

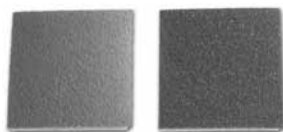

GREENWARE FILES

Lightweight, these two-sided flexible files cut cleaning time even on low-fired porcelain bisque.

3/4" x 7" Coarse GF2 \$3.89
1/2" x 5" Coarse GF3 \$2.99
1/2" x 5" Fine GF-01 \$1.29

GRIZZLY SANDING PADS

Use them on bisque, greenware, or wood. The even polish porcelain bisque. The two-sided pads are available in coarse or fine. \$1.99



CHAMOIS

1.5" x 4.5" square. \$1.25

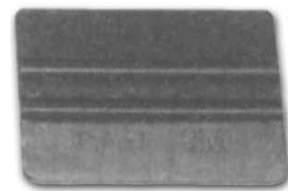

SQUEEGEE

A multi-use, long-lasting plastic tool for scraping clay, spreading clay, applying textures, refining clay sculpture, smoothing wet or dry clay surfaces, and much more. \$3.25

PERFECT HOLE CLEANERS

True to their name, you can use these to form or clean a variety of sized holes in greenware and low-fire porcelain. These abrasive nylon cleaners are washable.

PHC 1/4" to 1-1/2" holes \$4.99
PHCS 1/2" to 1" holes \$4.49



KEMPER QUICK CLEANERS

Washable sheets that can be used over and over again. Available in different grits: KQC 280: bisque and porcelain greenware KQC 400: porcelain bisque KQC 600: porcelain finishing and polishing (400 & 600 grits can also be used on fired underglazes, fired raised glaze surfaces, decal surfaces and china painted areas). \$2.39/each



STAINLESS STEEL SCRAPER

Made from heavy duty stainless steel, providing for a very rust proof and long lasting tool. Use for scraping, texturing, refining, applying, chopping, moving, pressing, cutting, mixing, combing, pressing, and smoothing. 6" x 4-1/2" \$8.54

